

Autotrol® Performa™ Valve

With 400 Series Control

Water Conditioning Control System
Dealer Installation, Operation and Maintenance Manual



Table of Contents

Installation	3
Location Selection	
Water Line Connection	
Drain Line Connection	
Brine Line	
Overflow Line Connection	
Placing Conditioner into Operation	5
Electrical Connection	
400 Series Control Settings	6
440i	
Programming	
460i	
Programming	
Time of Day Setting	
Hardness Setting	
Capacity Setting	
Calendar Override Setting	
Common Features	8
Salt Dial Adjustment	
Guest Cycle	
Manual Regeneration	
Removing the Valve Assembly for Servicing	10
Removing 440i or 460i for Servicing	10
Preventive Maintenance	11
Injector Screw and Injector	
Water Meter	
Specifications	12
Pressure Graphs	13
Identification of Control Valving	14
Valve Disc Principle of Operation	14
Flow Diagrams	14
Replacement Parts	16
Troubleshooting	19
Disinfection of Water Conditioners	22

Installation

All plumbing and electrical connections must conform to local codes.

Inspect unit carefully for carrier shortage or shipping damage.

This water conditioner's control valve conforms to NSF/ANSI 44 and 61 for materials and structural integrity only. Generic systems were tested and certified by WQA as verified by the performance data sheet.

Location Selection

1. The distance between the unit and a drain should be as short as possible.
2. If it is likely that supplementary water treatment equipment will be required, make certain adequate additional space is available.
3. Since salt must be added periodically to the brine tank, the location should be easily accessible.
4. Do not install any unit closer to a water heater than a total run of 10 feet (3 m) of piping between the outlet of the conditioner and the inlet to the heater. Water heaters can sometimes overheat to the extent they will transmit heat back down the cold pipe into the unit control valve.

Hot water can severely damage the conditioner. A 10-foot (3-m) total pipe run, including bends, elbows, etc., is a reasonable distance to help prevent this possibility. A positive way to prevent hot water flowing from heat source to the conditioner, in the event of a negative pressure situation, is to install a check valve in the soft water piping from the conditioner. **If a check valve is installed, make certain the water heating unit is equipped with a properly rated temperature and pressure safety relief valve. Also, be certain that local codes are not violated.**

5. Do not locate unit where it or its connections (including the drain and overflow lines) will ever be subjected to room temperatures under 34°F (1°C) or over 120°F (49°C).
6. Do not install unit near acid or acid fumes.
7. The use of resin cleaners in an unvented enclosure is not recommended.

Water Line Connection

The installation of a bypass valve system is recommended to provide for occasions when the water conditioner must be bypassed for hard water or for servicing.

The most common bypass systems are the Autotrol Series 1265 bypass valve (Figure 1) and plumbed-in globe valves (Figure 2). Though both are similar in function, the Autotrol Series 1265 bypass offers simplicity and ease of operation.

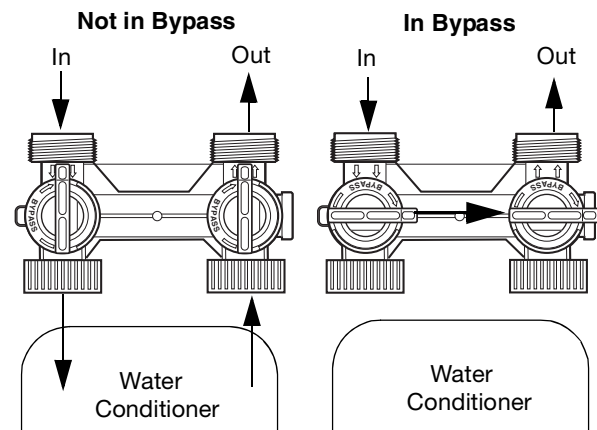

Figure 1 - Autotrol Series 1265 Bypass Valve

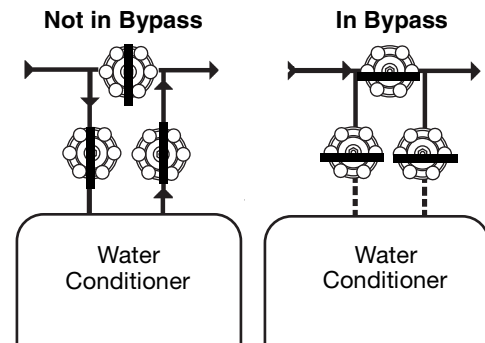

Figure 2 - Typical Globe Valve Bypass System

Drain Line Connection

Note: Standard commercial practices are expressed here. Local codes may require changes to the following suggestions.

1. Ideally located, the unit will be above and not more than 20 feet (6.1 m) from the drain. For such installations, using an appropriate adapter fitting, connect 1/2-inch (1.3-cm) plastic tubing to the drain line connection of the control valve.
2. If the backwash flow rate exceeds 5 gpm (22.7 Lpm) or if the unit is located more than 20 feet (6.1 m) from drain, use 3/4-inch (1.9-cm) tubing for runs up to 40 feet (12.2 m). Also, purchase appropriate fitting to connect the 3/4-inch tubing to the 3/4-inch NPT drain connection.
3. If the unit is located where the drain line must be elevated, you may elevate the line up to 6 feet (1.8 m) providing the run does not exceed 15 feet (4.6 m) and water pressure at conditioner is not less than 40 psi (2.76 bar). You may elevate an additional 2 feet (61 cm) for each additional 10 psi (0.69 bar).

4. Where the drain line is elevated but empties into a drain below the level of the control valve, form a 7-inch (18-cm) loop at the far end of the line so that the bottom of the loop is level with the drain line connection. This will provide an adequate siphon trap.
5. Where the drain empties into an overhead sewer line, a sink-type trap must be used.

IMPORTANT: Never insert drain line into a drain, sewer line or trap. Always allow an air gap between the drain line and the wastewater to prevent the possibility of sewage being back-siphoned into the conditioner.

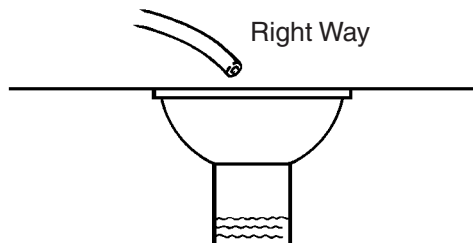

Figure 3

Note: Standard commercial practices have been expressed here. Local codes may require changes to these suggestions.

Brine Line Connection

It will be necessary to install the brine line to the brine fitting on the valve (3/8-inch NPT).

Be sure all fittings and connections are tight.

Overflow Line Connection

In the absence of a safety overflow and in the event of a malfunction, the BRINE TANK OVERFLOW will direct "overflow" to the drain instead of spilling on the floor where it could cause considerable damage. This fitting should be on the side of the cabinet or brine tank.

To connect overflow, locate hole on side of brine tank. Insert overflow fitting (not supplied) into tank and tighten with plastic thumb nut and gasket as shown (Figure 4). Attach length of 1/2-inch (1.3-cm) I.D. tubing (not supplied) to fitting and run to drain. Do not elevate overflow line higher than 3 inches (7.6 cm) below bottom of overflow fitting. Do not tie into drain line of control unit. Overflow line must be a direct, separate line from overflow fitting to drain, sewer or tub. Allow an air gap as per drain line instructions (Figure 3).

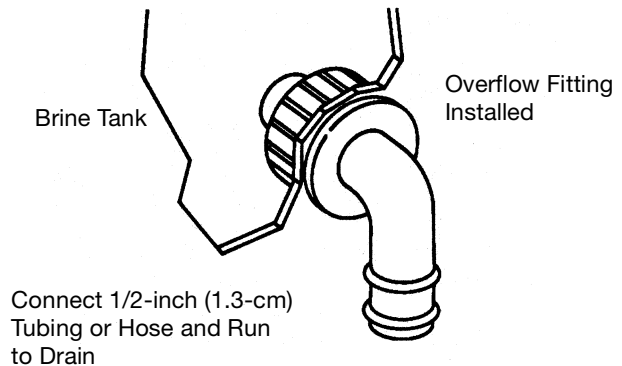

Figure 4

Placing Conditioner into Operation

After all previous steps have been completed, the unit is ready to be placed into operation. Follow these steps carefully.

1. Remove control valve cover by first releasing the plastic clip from the back of the cover. Pull back of cover slightly outward and lift up.

Note: The following steps will require turning the indicator knob (Figure 5 and Figure 6) to various positions. Manually rotate the camshaft **COUNTERCLOCKWISE** only until indicator knob points to desired position. (See manual regeneration sections for each control's manual operation.)

2. Rotate indicator knob **COUNTERCLOCKWISE** until it points directly to the word **BACKWASH**.
3. Fill media tank with water.
 - A. With water supply off, place the bypass valve(s) into the "not in bypass" position.
 - B. Open water supply valve very slowly to approximately the 1/4 open position.

IMPORTANT: If opened too rapidly or too far, media may be lost. In the 1/4 open position, you should hear air escaping slowly from the drain line.

- C. When all of the air has been purged from the tank (water begins to flow steadily from the drain), open the main supply valve all the way.
 - D. Allow water to run to drain until clear.
 - E. Turn off water supply and let the unit stand for about five minutes. This will allow all trapped air to escape from the tank.
4. Add water to brine tank (initial fill).

With a bucket or hose, add approximately 4 gallons (15 liters) of water to brine tank. If the tank has a salt platform above the bottom of the tank, add water until the level is approximately 1 inch (25 mm) above the platform.

5. Place the conditioner into operation.
 - A. With the water supply valve completely open, carefully advance the indicator knob **COUNTERCLOCKWISE** to the center of the **BRINE REFILL** position. Hold at this position until water starts to flow through the brine line into the brine tank. Do not run for more than one or two minutes.
 - B. Advance the indicator knob **COUNTERCLOCKWISE** until it points to the center of the **BRINE/SLOW RINSE** position.
 - C. With the conditioner in this position, check to see if water is being drawn from the brine tank. The water level in the brine tank will recede very slowly. Observe water level for at least three minutes. If the water level does not recede, or if it goes up, reference the **Troubleshooting** section.
 - D. Advance the indicator knob **COUNTERCLOCKWISE** to the **SERVICE** position and run water from a nearby faucet until the water is clear and soft.

Electrical Connection

100 VAC, 115 VAC, and 230 VAC units: Remove twist tie from the power cord and extend cord to its full length. Make sure power source matches the rating printed on the control. Be certain a wall switch does not control the outlet.

12 VAC: Connect the plug of the transformer (supplied) secondary cable to the mating socket at the rear or bottom of the timer housing. Be certain the transformer is secure and is plugged into a power source of correct voltage that is not controlled by a wall switch.

400 Series Control Settings

440i Control

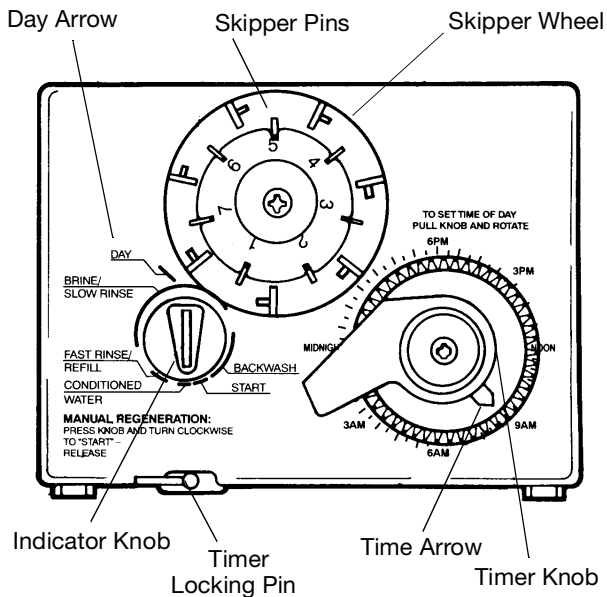

Figure 5

Programming

- Set days of regeneration on skipper wheel (Figure 5).
 - Pull all skipper pins outward (away from control).
 - Rotate skipper wheel until day arrow points to current day or number 1.
 - Depress skipper pin(s) at day(s) for which regeneration is desired.
- Set the time of day.
 - Grasp timer knob and pull outward.
 - Rotate in either direction until the timer arrow points to the actual time of day.
 - Release timer knob.

Note: With the time of day properly set, the conditioner will regenerate at about 2:30 a.m. If you prefer to have the unit regenerate at an earlier or later time, simply set current time-of-day accordingly (e.g., to have the unit regenerate at 4:30 a.m.—two hours later—set the clock two hours earlier than the actual time of day.)

Note: The Timer Locking Pin should always be horizontal (Figure 5) during operation.

460i Control

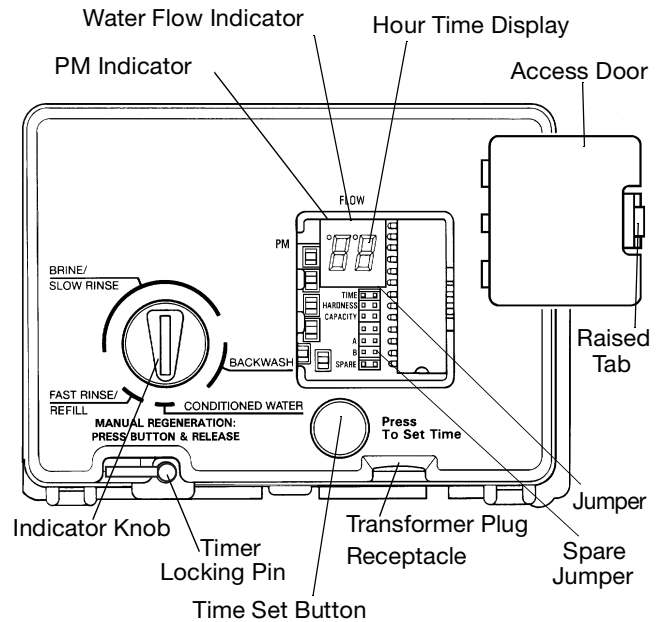

Figure 6

Programming

Plug the wall-mount transformer into a functioning electrical outlet that is not controlled by a switch. Plug the transformer into the transformer plug receptacle on the control.

Open the access door by pushing the raised tab on the door toward the left while pulling the tab out (Figure 6).

Time of Day Setting

With the jumper on the set of pins next to the word TIME (Figure 7), set the time of day to the closest hour by pressing the black TIME SET button. PM hours are indicated by a light next to the letters PM on the display window.

Note: The use of a small needle-nose pliers will aid in moving the jumper.

Note: The unit is factory set to regenerate at 2:00 a.m. If you prefer to have the unit regenerate at an earlier or later time, simply set the current time of day accordingly (e.g., to have the unit regenerate at 4:00 a.m.—two hours later—set the clock two hours earlier than the actual time of day.)

Note: The Timer Locking Pin should always be horizontal (Figure 6) during operation.

Hardness Setting

Move the jumper to the set of pins next to the word **HARDNESS** (Figure 8). Press the black TIME SET button until the hardness of the incoming water supply is displayed. The hardness range is from 1 to 99 grains per gallon.

To change water hardness stated in parts per million (PPM) to grains per gallon (GPG) use this formula:

$$\frac{\text{Parts per Million}}{17.1} = \text{Grains per Gallon}$$

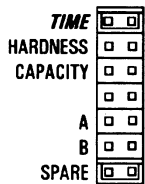

Figure 7

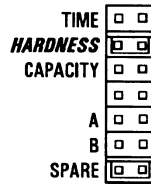

Figure 8

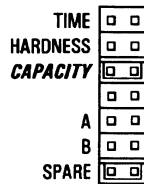

Figure 9

4. Depress the black TIME SET button. The numbers will roll from "0" to "15." Release the switch at the desired number of days for the calendar override. For example, releasing the switch at "10" would program a 10-day calendar override.
5. Disconnect power.
6. Place jumper back on TIME and reconnect power.
7. The calendar override program is maintained during power outages by the NOVRAM circuitry.
8. To remove the calendar override, follow the same steps above and program back to "0."

Capacity Setting

Move the jumper to the set of pins next to the word **CAPACITY** (Figure 9). Press the black TIME SET button until the correct capacity value is displayed. The capacity range is 1 to 99 kilograins. Refer to the Suggested Salt Dial Settings table (8).

Return the jumper to the top set of pins next to the word **TIME** and replace the access door. **The jumper must NOT be left on any pins other than the top pair next to the word TIME.** Otherwise, the unit may show a blank display.

Note: A spare jumper is located on the bottom set of pins.

In the event that the hardness or capacity setting must be changed, simply follow the appropriate steps described above.

Calendar Override Setting

1. Disconnect power.
2. Place jumper on Pin A and reconnect power.
3. Move jumper to Pin B. A zero will appear, indicating zero days of calendar override. All 460i controllers are preprogrammed in this manner at the manufacturer.

Common Features

When using the Performa valve with the 440i or 460i controls, there are several features and procedures that are unique to the 400 series controls. They are as follows:

Salt Dial Adjustment

These models may be adjusted to produce maximum to minimum conditioning capacities by setting the salt dial, which controls the amount of salt used per regeneration. When desired, the minimum setting may be used on installations if the frequency of regeneration is increased to compensate for lower regenerated conditioning capacity. The installing dealer will set the unit for proper salt usage. Further adjustments are needed only if the hardness of the water supply changes or if water use changes dramatically. Capacity will need to be adjusted accordingly.

To adjust salt dosage, insert a small screwdriver into the white indicator knob and move pointer to proper salt setting (Figure 10).

Note: To convert the salt settings from English to metric, divide by 2.2 (e.g., 12 pounds ÷ 2.2 = 5.5 kg of salt).

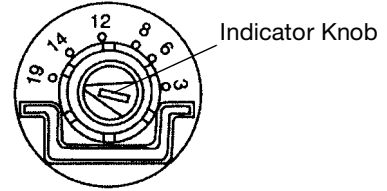

Figure 10

Table 1 – Suggested Salt Dial Settings (Pounds of Salt) For Various Size Softeners

Capacity Setting (Kilograins)	0.5 Ft ³	0.75 Ft ³	1.0 Ft ³	1.25 Ft ³	1.5 Ft ³	1.75 Ft ³	2.0 Ft ³	2.5 Ft ³
12	4.5	—	—	—	—	—	—	—
16	9.0	5.5	—	—	—	—	—	—
20	—	8.5	6.0	—	—	—	—	—
24	—	14.0	8.5	7.0	—	—	—	—
30	—	—	15.0	11.0	9.0	—	—	—
32	—	—	18.5	12.5	10.0	9.0	—	—
35	—	—	—	16.0	12.0	10.0	9.0	—
40	—	—	—	23.0 ¹	17.0	14.0	12.0	—
48	—	—	—	—	28.0 ¹	21.0 ¹	17.0	14.0
60	—	—	—	—	—	—	30.0 ¹	21.0 ¹

¹ When using the 440i or 460i you must use Extra Salt cam and divide the suggested setting by 2 to accomplish these settings.

The amount of salt placed in the brine tank has nothing to do with the amount of salt used during the regeneration cycle. Water will dissolve and absorb salt only until it becomes saturated. A given amount of brine (salt-saturated water) contains a specific amount of salt. The salt dial controls the amount of brine used during the regeneration cycle (e.g., when set at 15 pounds (6.8 kg) the amount of brine the conditioner will use for each regeneration will contain 15 pounds (6.8 kg) of salt, etc.)

Never let the amount of salt in the brine tank be lower than the normal liquid level. Do not overload the brine tank with salt.

Guest Cycle

When abnormally high water usage exhausts your water conditioner's capacity ahead of schedule, an extra regeneration can be achieved. Depress the indicator knob on the 440i (Figure 5) with a wide-blade screwdriver and turn **COUNTERCLOCKWISE** to **START** to initiate a regeneration. For the 460i, simply depress the indicator knob (Figure 6). It will take a few minutes for regeneration to start. A normal regeneration will take approximately two hours.

Manual Regeneration

Electricity is used only to run the control and to rotate the camshaft. All other functions are operated by water pressure. Therefore, in the event of a power outage, all the regeneration positions may be dialed manually by depressing the indicator knob and turning **COUNTERCLOCKWISE** (Figure 5 and Figure 6). The following cycle times should be used for proper regeneration:

BACKWASH—14 minutes

BRINE/SLOW RINSE—52 minutes

FAST RINSE/REFILL—10 minutes

PURGE—6 minutes

Do not exceed 10 minutes for the **FAST RINSE/REFILL** cycle as this will cause excessive salt usage during the next regeneration and possibly a salt residue in the softened water.

Removing the Valve Assembly for Servicing

1. Unplug the power cord.
2. Shut off water supply or put bypass valve(s) into bypass position.
3. Remove cover and with screwdriver, relieve tank pressure by pushing open valve No. 7 (rear flapper) on control as shown (Figure 10).

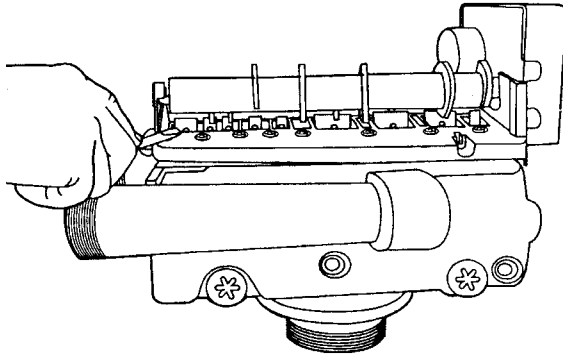

Figure 10

4. When used with a globe valve bypass, loosen and detach the inlet, outlet, brine and drain lines from the valve. If using the 1265 bypass, loosen and remove valve from bypass as well as loosening and removing the brine and drain lines.
5. Unscrew valve (counterclockwise) and remove valve from tank.
6. To replace the control valve, reverse the above procedure.

Removing 440i or 460i for Servicing

1. Unplug the power cord.
2. Remove cover.
3. Align the indicator arrow on the rear of the camshaft with the top of the rear hoop of the top plate (Figure 11).

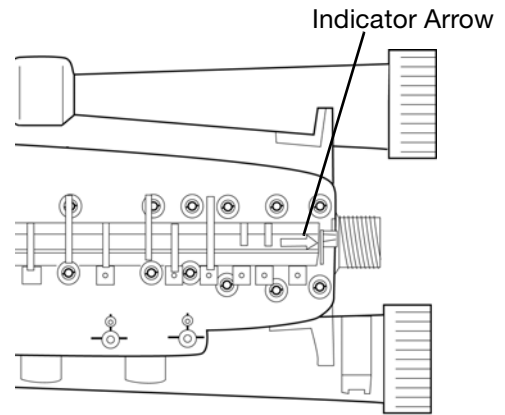

Figure 11

4. Remove the camshaft by carefully pushing the securing tab, located at the rear of the camshaft, away from the camshaft until the tab disengages from the camshaft. Push the back of the camshaft down and out to the inlet side of the valve (Figure 12).

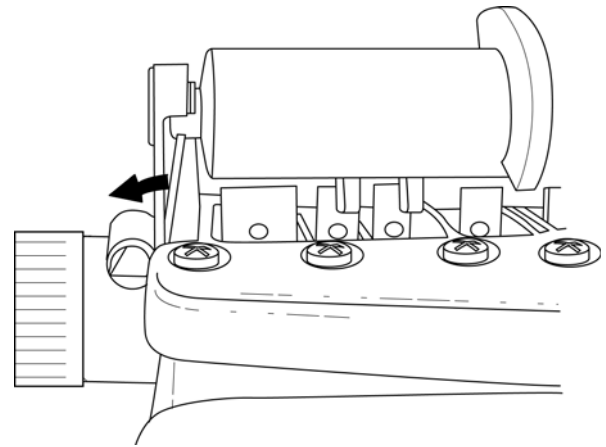

Figure 12

5. Disengage the front of the camshaft from the output gear of the control.
6. Remove the timer locking pin and lift the control straight up and off of the valve.
7. To reinstall the camshaft and control, reverse the above procedures.

**RoVer is a trademark of Hach Chemical Company.*

Preventive Maintenance

Injector Screen and Injector

Inspect and clean brine tank and screen filter on end of brine pickup tube once a year or when sediment appears in the bottom of the brine tank.

Clean injector screen and injector once a year:

1. Unplug the wall-mount transformer.
2. Shut off water supply or put bypass valve(s) into bypass position.
3. Relieve system pressure by opening valve No. 7 (at rear) with a screwdriver (Figure 10).
4. Using a screwdriver, remove injector screen and injector cap (Figure 13).
5. Clean screen using a fine brush. Flush until clean.
6. Using a needle-nose pliers, pull injector straight out.
7. Flush water into the injector screen recess of the valve body to flush debris out through the injector recess.
8. Clean and flush the injector.
9. Lubricate the O-rings on the injector, injector cap and injector screen with silicone lubricant **only!**
10. Reinstall the injector, injector cap and injector screen.

IMPORTANT: Do not overtighten the plastic cap. Seat the cap lightly into position. Overtightening may cause breakage of the plastic cap that may not be immediately evident.

11. Plug the wall-mount transformer into outlet; reset clock if necessary.
12. Slowly open water supply valve or return bypass valve(s) to the "service" position.

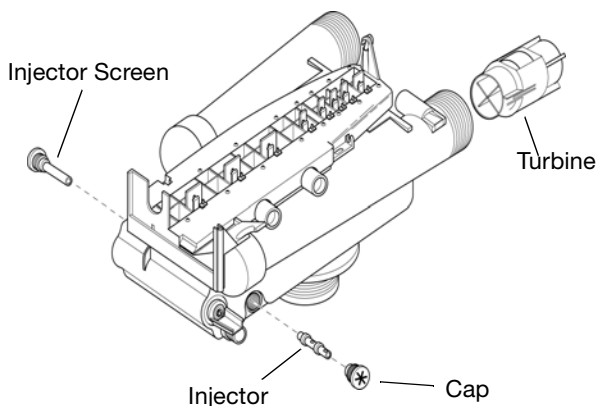

Figure 13

Water Meter Maintenance

Note: A water meter is used only with the 460i control. If you are using the 440i control, this section does not pertain to your conditioner.

The metering device used with the 460i demand control may require simple maintenance. In rare instances, the turbine wheel of the water meter can collect small particles of oxidized iron, eventually preventing the wheel from turning.

1. Shut off the water supply or put the bypass valve(s) into the bypass position.
2. Relieve pressure by opening the Backwash Drain Valve (the seventh back from the control) with a screwdriver (Figure 10).
3. Loosen and remove the pipe/tube adapters or 1265 bypass from the inlet and outlet of the valve body.
4. Using a needle-nose pliers, remove the turbine from the outlet housing. Grasp one of the four vanes of the outer gland and pull straight out to remove turbine assembly from the outlet of the valve (Figure 13).
5. Carefully remove the turbine wheel from the housing. Use a toothbrush to lightly scrub the iron off the magnet. Iron buildup on the surfaces can be removed by soaking the wheel in a mild sodium hydrosulfite (such as RoVer*) solution for a few minutes. Flush thoroughly with water.
6. Carefully reinstall the turbine wheel into the turbine cage housing. Make sure that the shaft of the wheel seats into the bearing of the cage. Reassemble the turbine cage and check that the wheel rotates freely.
7. Reinstall the turbine cage into the outlet of the valve.
8. Reinstall the pipe/tube adapters or 1265 bypass to the inlet and outlet of the valve.
9. Turn on the water supply or put the bypass valve(s) into the service position and purge the air out of the system.

To check for proper meter operation, open a downstream faucet and observe the water flow indication on the control display.

Specifications

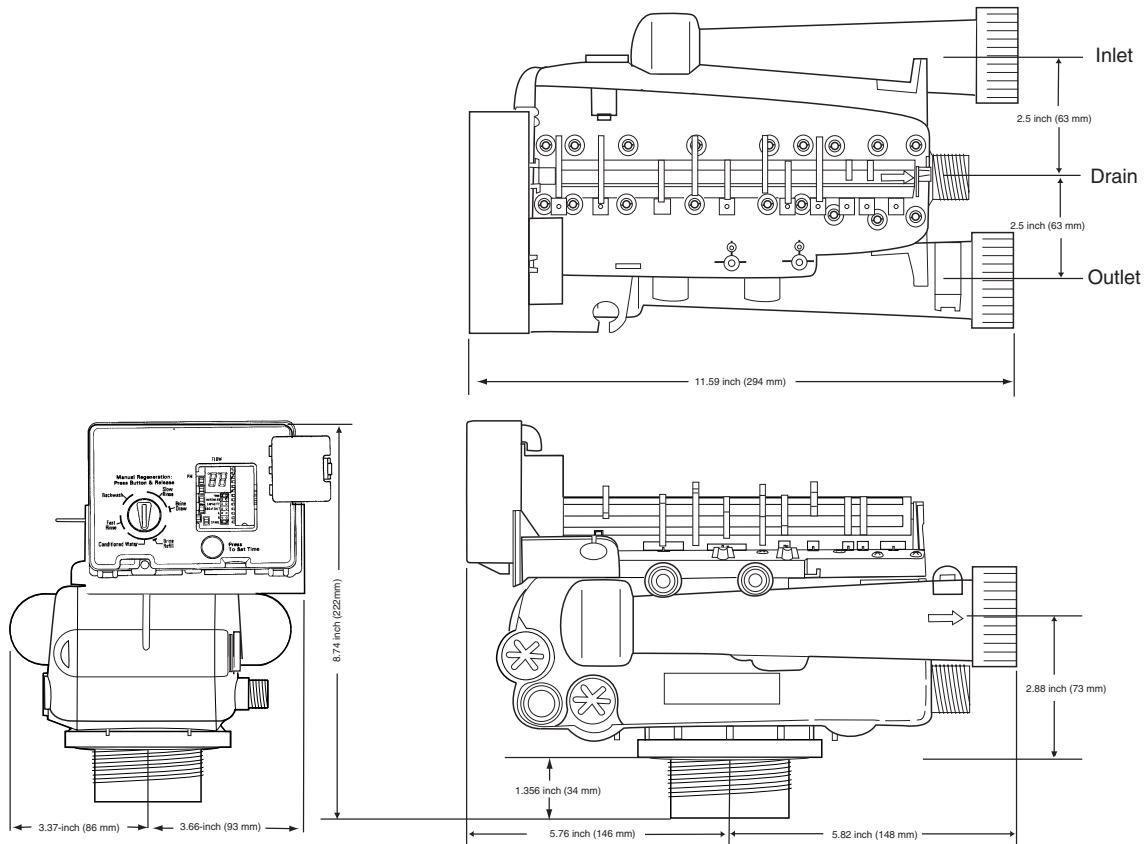

Hydrostatic Test Pressure	300 psi (20.69 bar)
Working Pressure	20-125 psi (1.38 - 8.62 bar)
Standard Electrical Rating	115V 60 Hz
Optional Electrical Rating	115V 50 Hz, 230V 50 Hz, 200V 60 Hz, 24V 60 Hz, 24V 50 Hz, 100V 60 Hz, 100V 50 Hz, 12V 50 Hz/transformer, 12V 60 Hz/transformer
Electrical Cord (standard rating)60 inch (1.5 m) 3-wire with plug
Pressure Tank Thread	2 1/2 inch-8 male
Riser Pipe Diameter Required	1.050 inch OD (26.7 mm)
Riser Pipe Length	1-1/8 ±1/8 inches (31.8 mm) higher than the top of mineral tank
Standard Connection	1-inch (25.4-mm) copper tube adapters
Optional Connections	3/4-inch, 22-mm, and 28-mm copper tube adapters 3/4-inch BSPT, 1-inch BSPT, 1-inch NPT brass pipe adapters 3/4-inch, 1-inch, 25-mm CPVC tube adapters
Brine Line Connection	3/8-inch NPT male
Drain Line Connection	3/4-inch NPT male
Optional Bypass Valve	Rotating handles, full 1-inch porting, reinforced Noryl
Control Module, Tank Adapter	Reinforced Noryl
Rubber Goods	Compounded for cold water service
Program Clock (Timer)	440i: Available in 6- or 7-day English, German, French, Italian, Spanish, Japanese 460i: Available in English, German, French, Italian, Spanish, Japanese
Brine Refill Control	1 to 10 lbs (0.45 to 4.5 kg) of salt or 3 to 19 lbs (1.4 to 8.6 kg) of salt
Injector Size "A" White	Nozzle .042-inch (1.1-mm) diameter, Throat .089-inch (2.3-mm) diameter
Injector Size "B" Blue	Nozzle .052-inch (1.3-mm) diameter, Throat .099-inch (2.5-mm) diameter
Injector Size "C" Red	Nozzle .059-inch (1.5-mm) diameter, Throat .099-inch (2.5-mm) diameter
Injector Size "D" Green	Nozzle .071-inch (1.8-mm) diameter, Throat .147-inch (3.7-mm) diameter
Internal Backwash Controllers	7- through 14-inch (17.8- though 35.6-cm) diameter media tanks All sizes to flow 4.5 gpm/sq ft (183 L/m/m ²) of bed area. For tank sizes above 14 inches in diameter, use an external flow control.

Pressure Graphs

Injector #1031363
"A" in a 268 Valve

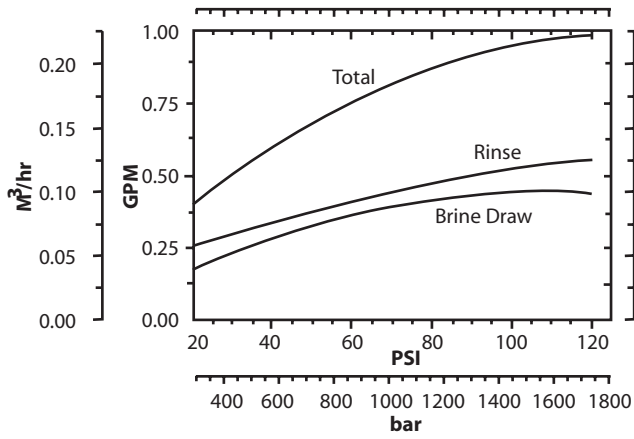

Injector #1031364
"B" in a 268 Valve

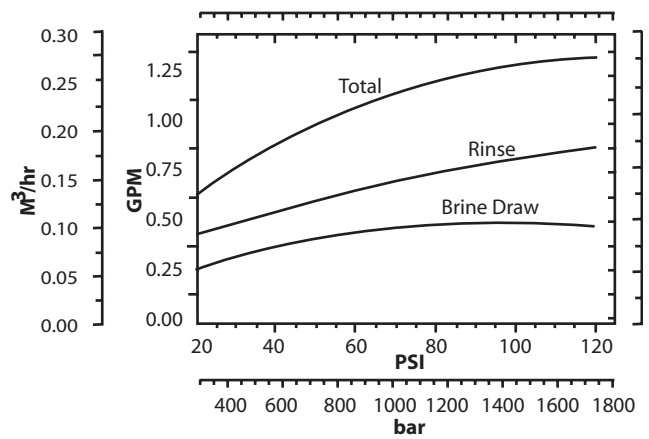

Injector #1031365
"C" in a 268 Valve

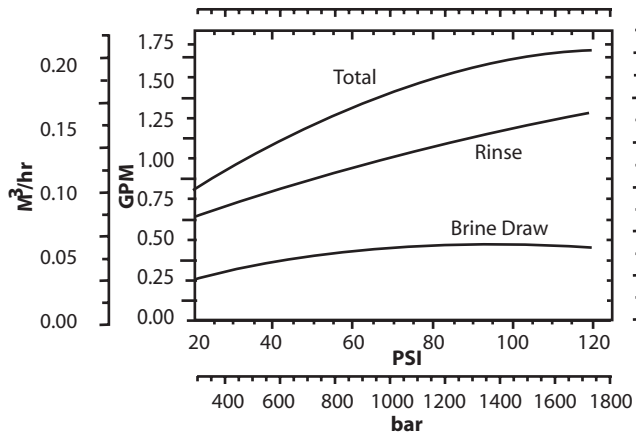

Injector #1030272
"D" in a 268 Valve

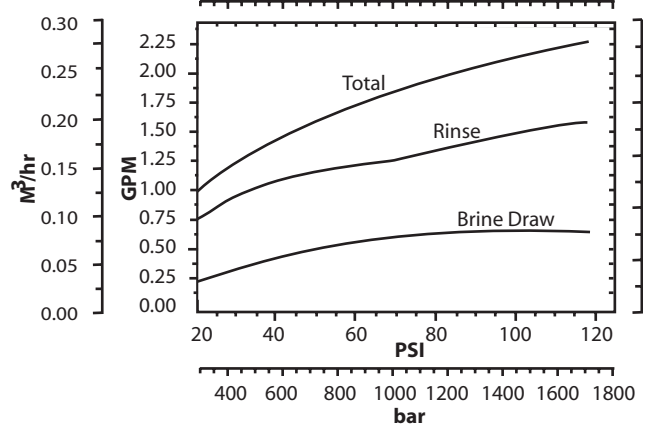

Backwash Number	7	8	9	10	12	13	14
Flow (GPM*)	1.2	1.6	2.0	2.5	3.5	4.1	4.8
Flow (LPM*)	4.5	6.0	7.6	9.5	13.2	15.5	18.2

*Approximate flow rates at 60 psi (4.14 bar)

Identification of Control Valving

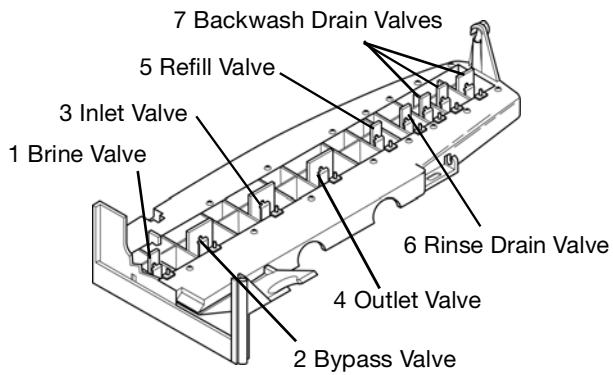

Valve Disc Principle of Operation

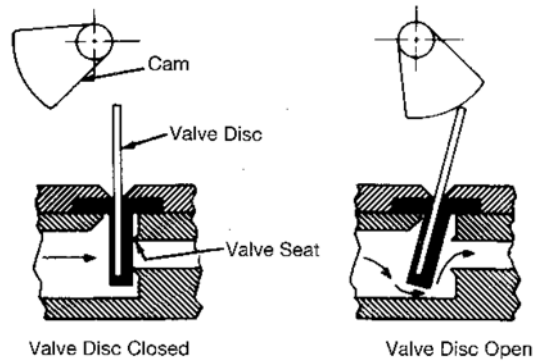

Flow Diagrams

1 Service Position

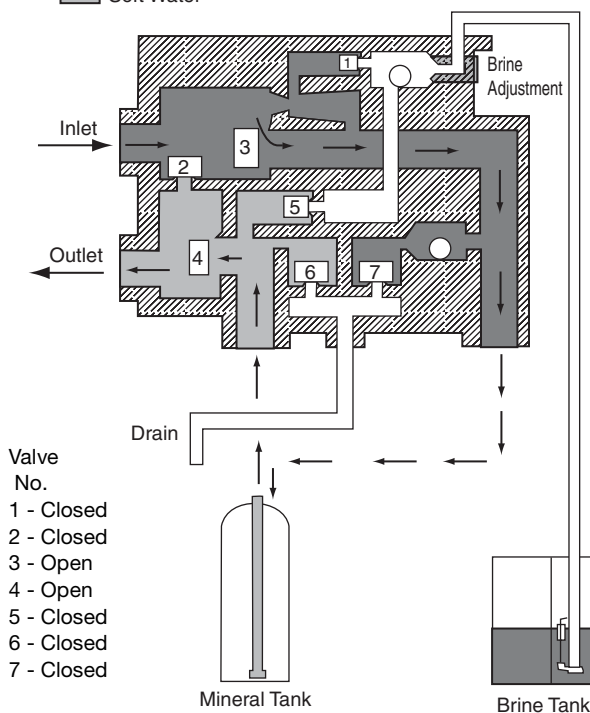
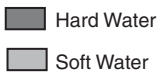

2 Backwash Position

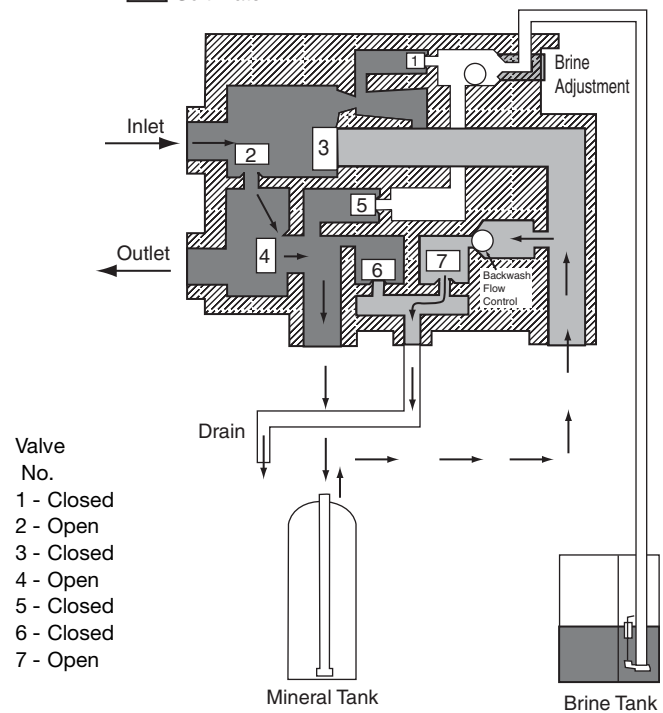

3 Brining/Slow Rinse Position

Hard Water
 Soft Water

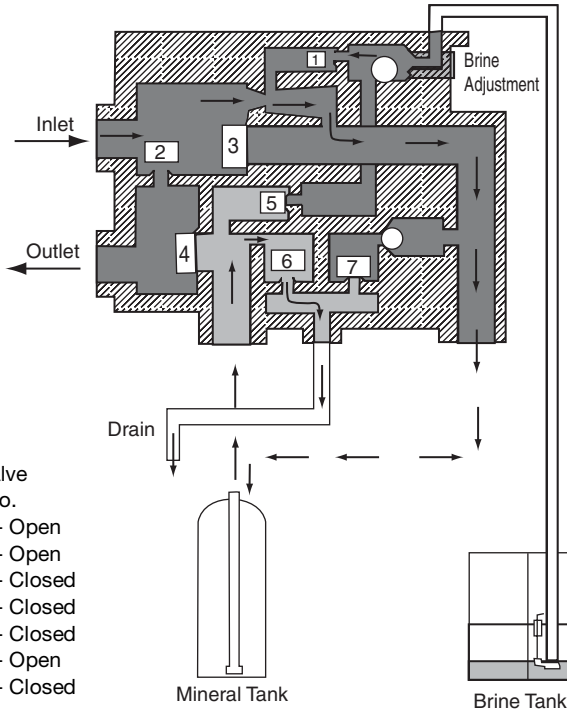

- Valve No.
- 1 - Open
 - 2 - Open
 - 3 - Closed
 - 4 - Closed
 - 5 - Closed
 - 6 - Open
 - 7 - Closed

Mineral Tank

Brine Tank

4 Purge Position

Hard Water
 Soft Water

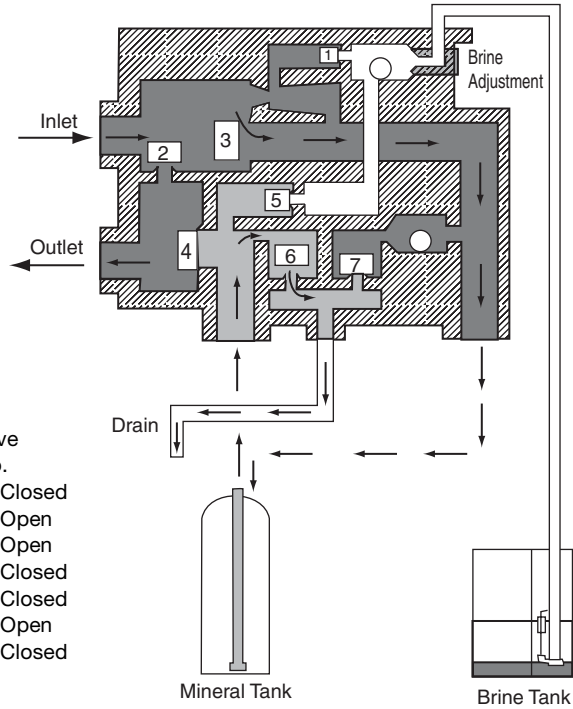

- Valve No.
- 1 - Closed
 - 2 - Open
 - 3 - Open
 - 4 - Closed
 - 5 - Closed
 - 6 - Open
 - 7 - Closed

Mineral Tank

Brine Tank

5 Brine Refill Position

Hard Water
 Soft Water

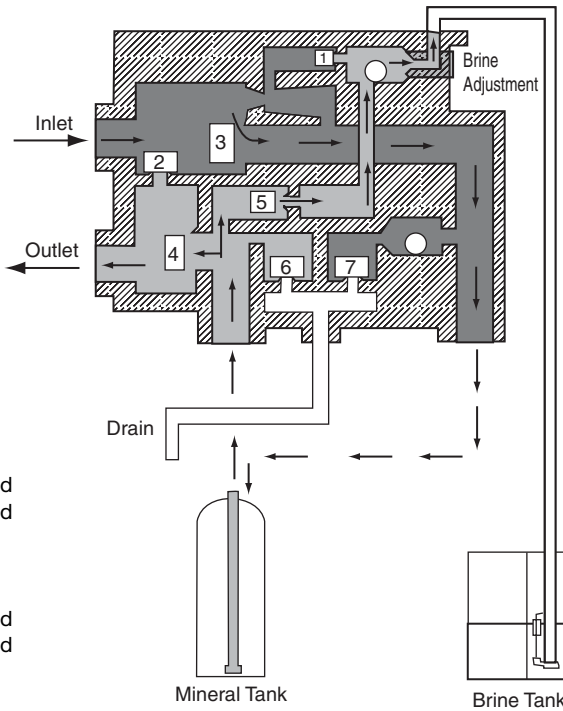

- Valve No.
- 1 - Closed
 - 2 - Closed
 - 3 - Open
 - 4 - Open
 - 5 - Open
 - 6 - Closed
 - 7 - Closed

Mineral Tank

Brine Tank

Replacement Parts

Performa Valve

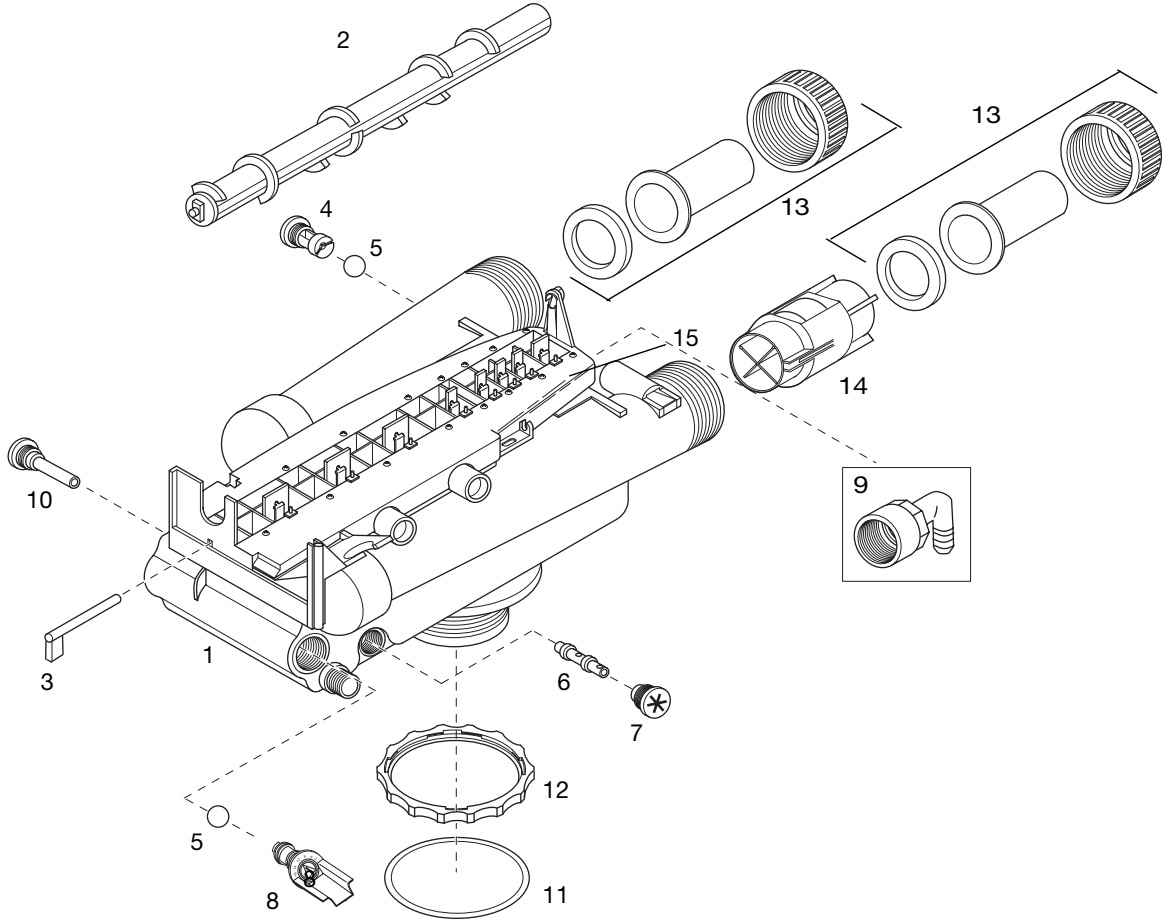

Parts List

Part				Part			
Code	No.	Description	Qty.	Code	No.	Description	Qty.
1	1035606	Valve Assembly, w/o Flow Controls (440i, 460i)	1	8		Brine Refill Control (440i and 460i):	1
2		Camshaft:	1	1034261		1 to 10 Pounds Salt	
	1035625	440i, 460i Standard		1034263		3 to 19 Pounds Salt	
	1035627	440i, 460i Extra Salt **		9	1002449	Drain Fitting Elbow (3/4" hose barbed)	1
3	1031391	Timer Locking Pin	1	10	1000226	Screen/Cap Assembly	1
4		Drain Control Assembly:	1	11	1010429	O-Ring	1
	1000209	No. 7 (1.2 gpm; 4.5 Lpm)		12	1035622	Tank Ring	1
	1000210	No. 8 (1.6 gpm; 6.1 Lpm)		13		Plumbing Adapter Kits:	1
	1000211	No. 9 (2.0 gpm; 7.6 Lpm)		1001606		3/4-inch Copper Tube Adapter Kit	
	1000212	No. 10 (2.5 gpm; 9.5 Lpm)		1001670		1-inch Copper Tube Adapter Kit	
	1000213	No. 12 (3.5 gpm; 13.2 Lpm)		1041210		1-1/4-inch Copper Tube Adapter Kit	
	1000214	No. 13 (4.1 gpm; 15.5 Lpm)		1001608		22-mm Copper Tube Adapter Kit	
	1000215	No. 14 (4.8 gpm; 18.2 Lpm)		1001609		28-mm Copper Tube Adapter Kit	
5	1030502	Ball, Flow Control	2	1001613		3/4-inch CPVC Tube Adapter Kit	
6		Injector Assembly:	1	1001614		1-inch CPVC Tube Adapter Kit	
	1032970	"A" Injector - White		1001615		25-mm CPVC Tube Adapter Kit	
	1032971	"B" Injector - Blue		1001769		3/4-inch NPT Plastic Pipe Adapter Kit	
	1032972	"C" Injector - Red		1001603		1-inch NPT Plastic Pipe Adapter Kit	
	1030272	"D" Injector - Green		1001604		3/4-inch BSPT Plastic Pipe Adapter Kit	
7		Injector Cap Assembly:	1	1001605		1-inch BSPT Plastic Pipe Adapter Kit	
	1000217	"A" Cap		1001611		3/4-inch BSPT Brass Pipe Adapter Kit	
	1000218	"B" Cap		1001610		1-inch NPT Brass Pipe Adapter Kit	
	1000219	"C" Cap		1001612		1-inch BSPT Brass Pipe Adapter Kit	
	1030303	"D" Cap		14	1033444	Turbine Assembly (460i only)	1
				15	1001580	Spring, Flapper Valve	
				*		Valve Disc Kit:	
				1041174		Standard	
				1041175		Severe Service	
				*	1000062	I-Lid Cover	1

* Not Shown

** Soft water refill is not available with the extra salt cam

440i Control

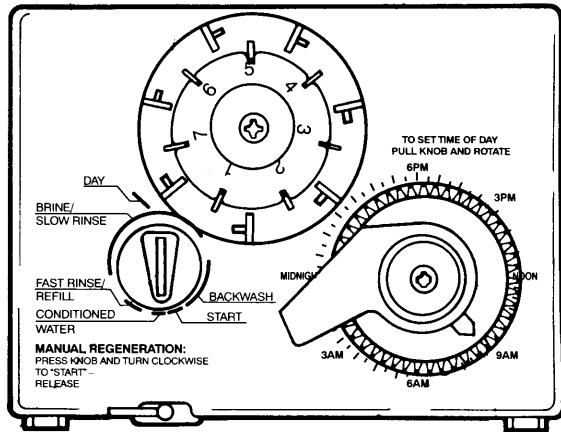

1

460i Control

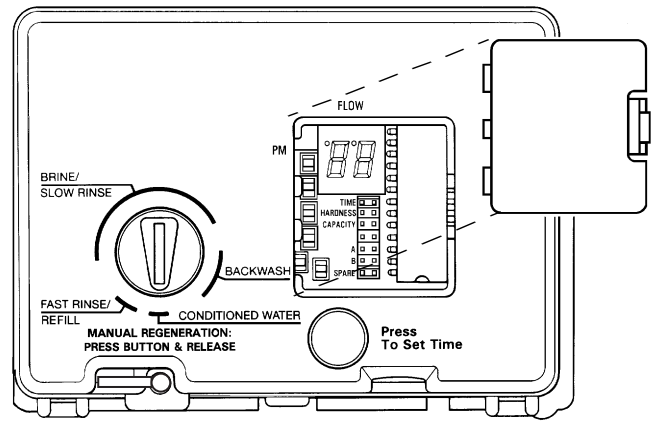

2

1265 Bypass

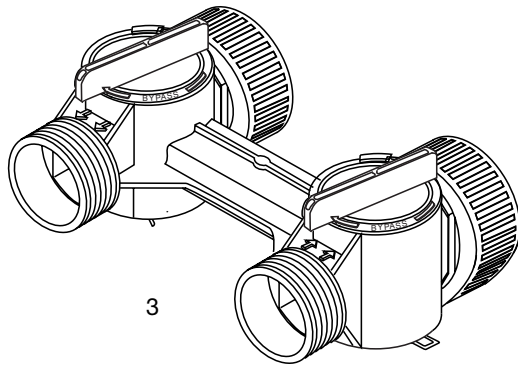

3

Part			
Code	No.	Description	Qty.
1		440i Control (6 day or 7 day)	1
2		460i Control	1
3	1040930	1265 Bypass	1
*	1000811	Transformer (440i, 460i):	1
*	1000907	Transformer Extension Cord 15 feet (4.6 m)	1
*	1034264	Y-Splitter (run 2 units from 1 transformer)	1

* Not Shown

Troubleshooting

The technology upon which the Autotrol Performa control valve is based is well established and proven in service over many years. However, should a problem or question arise regarding the operation of the system, the control can very easily be serviced. For parts mentioned, refer to exploded views in the **Replacement Parts** section of this manual.

IMPORTANT: Service procedures that require the water pressure to be removed from the system are marked with a ! after the possible cause. To remove water pressure from the system, put the bypass valve or three-valve bypass into the bypass position and open the backwash drain valve (the seventh valve back from the control) with a screwdriver. Restore system water pressure when the service work is completed.

Valve Troubleshooting

Problem	Possible Cause	Solution
1. Control will not draw brine.	A. Low water pressure. B. Restricted drain line. C. Injector plugged ! D. Injector defective ! E. Valve (2 and/or 4) not closed.	A. Set pump to maintain 30 psi at conditioner. B. Remove restriction. C. Clean injector and screen. D. Replace injector. E. Remove foreign matter from disc and check disc for closing by pushing in on stem. Replace if needed.
2. Brine tank overflow.	A. Brine valve (1) being held open. B. Uncontrolled brine refill flow rate ! C. Valve (3 or 4) not closed during brine draw causing refill. D. Air leak in brine line.	A. Manually operate valve stem to flush away obstruction. B. Remove variable salt controller to clean. C. Flush out foreign matter by holding disc open and manually operating valve stem. D. Check all connections in brine line for leaks. Refer to instructions.
3. System using more or less salt than salt control is set for.	A. Inaccurate setting. B. Foreign matter in controller causing incorrect flow rates ! C. Defective controller.	A. Correct setting. B. Remove variable salt controller and flush out foreign matter. Manually position control to brine draw to clean controller (after so doing, position control to "purge" to remove brine from tank). C. Replace controller.
4. Intermittent or irregular brine draw.	A. Low water pressure. B. Defective injector !	A. Set pump to maintain 30 psi at conditioner. B. Replace both injector and injector cap.
5. No conditioned water after regeneration.	A. Unit did not regenerate. B. No salt in brine tank. C. Plugged injector !	A. Check for power. B. Add salt. C. Clean injector. Flush with water.
6. Control backwashes at excessively low or high rate.	A. Incorrect backwash controller used. B. Foreign matter affecting controller operation !	A. Replace with correct size controller. B. Remove controller and ball. Flush with water.
7. Flowing or dripping water at drain or brine line after regeneration.	A. Drain valve (5 or 6) or brine valve (1) held open by foreign matter or particle. B. Valve stem return spring on top plate weak.	A. Manually operate valve stem to flush away obstruction. B. Replace spring.
8. Hard water leakage during service.	A. Improper regeneration. B. Leaking of bypass valve ! C. O-ring around riser tube damaged !	A. Repeat regeneration making certain that the correct salt dosage is set. B. Replace O-ring. C. Replace O-ring.

440i Control Troubleshooting

Problem	Possible Cause	Solution
1. Control will not regenerate automatically.	<ul style="list-style-type: none"> a. Transformer or motor not connected. B. Defective timer motor. C. Skipper pins not down on timer skipper wheel. D. Binding in gear train of timer. 	<ul style="list-style-type: none"> A. Connect power. B. Replace motor. C. Depress pins for days regeneration required. D. Replace timer.
2. Control regenerates at wrong time of day.	<ul style="list-style-type: none"> A. Time set incorrectly. 	<ul style="list-style-type: none"> A. Correct time setting according to instructions.

460i Control Troubleshooting

Problem	Possible Cause	Solution
1. Clock does not display time of day.	<ul style="list-style-type: none"> a. Transformer cord unplugged. B. No electric power at outlet. C. Defective transformer. D. Defective circuit board. 	<ul style="list-style-type: none"> A. Connect power. B. Repair outlet or use working outlet. C. Replace transformer. D. Replace timer.
2. Clock does not display correct time of day.	<ul style="list-style-type: none"> A. Outlet operated by switch. B. Incorrect voltage or frequency (Hz). C. Power outages. 	<ul style="list-style-type: none"> A. Use outlet not controlled by switch. B. Replace timer with one of correct voltage and frequency (Hz). C. Reset clock.
3. Time display continues to advance.	<ul style="list-style-type: none"> A. Defective time set switch. 	<ul style="list-style-type: none"> A. Replace timer.
4. Time display shows something other than time of day.	<ul style="list-style-type: none"> A. Electrical interference. B. Defective circuit board. 	<ul style="list-style-type: none"> A. Disconnect power to unit. Restore power and reset time of day. B. Replace timer.
5. No water flow display when water is flowing.	<ul style="list-style-type: none"> A. Bypass valve in bypass. B. Meter probe disconnected or not fully connected to meter housing. C. Restricted meter turbine rotation due to foreign matter in meter. D. Defective meter probe. E. Defective circuit board. 	<ul style="list-style-type: none"> A. Shift bypass valve to not-in-bypass position. B. Fully insert probe into meter housing. C. Remove meter housing, free up turbine and flush with clean water. Do not disassemble turbine from meter housing. Turbine should spin freely. If not, replace meter ! D. Replace timer. E. Replace timer.
6. Control regenerates at wrong time of day.	<ul style="list-style-type: none"> A. Power outages. B. Clock set incorrectly. 	<ul style="list-style-type: none"> A. Reset clock to correct time of day. B. Reset clock to correct time of day.
7. Timer stalled in regeneration cycle.	<ul style="list-style-type: none"> A. Motor dead. B. Motor runs backward. C. No electric power at outlet. D. Broken gear. E. Defective switch. F. Air leak in brine connections. G. Binding of camshaft. H. Water pressure greater than 125 psi during regeneration. I. Defective circuit board. 	<ul style="list-style-type: none"> A. Replace timer. B. Replace timer. C. Repair outlet or use working outlet. D. Replace timer. E. Replace timer. F. Check all junction points and make appropriate corrections. G. Remove foreign object obstruction from valve discs or camshaft. H. Install pressure regulator ! I. Replace timer.
8. Continuous regeneration. Camshaft does not stop at the end of regeneration.	<ul style="list-style-type: none"> A. Broken switch activator on gear. B. Defective switch. 	<ul style="list-style-type: none"> A. Replace timer. B. Replace timer.

Problem	Possible Cause	Solution
9. Control will not regenerate automatically or when button is pressed.	<ul style="list-style-type: none"> A. Electric cord unplugged. B. No electric power at outlet. C. Defective motor. D. Broken gear. E. Binding in gear train. F. Defective switch. 	<ul style="list-style-type: none"> A. Connect power. B. Repair outlet or use working outlet. C. Replace timer. D. Replace timer. E. Replace timer. F. Replace timer.
10. Control will not regenerate automatically but will regenerate when button is pressed.	<ul style="list-style-type: none"> A. If water flow display is not operative, refer to Item 5. B. Defective circuit board. C. Incorrect hardness and capacity settings. 	<ul style="list-style-type: none"> A. Same as Item 5. B. Replace timer. C. Set to correct values. See Programming section.
11. Run out of soft water between regenerations.	<ul style="list-style-type: none"> A. Improper regeneration. B. Fouled softener resin. C. Incorrect salt setting. D. Incorrect harness or capacity settings. E. Water hardness has increased. F. Restricted meter turbine rotation due to foreign material in meter housing. G. Excessive water usage below 1/5 gallon per minute. 	<ul style="list-style-type: none"> A. Repeat regeneration, making certain that correct salt dosage is used. B. Use resin cleaner. See Note 1. C. Set salt control to proper level. See Salt Setting chart. D. Set to correct values. See Programming section. E. Set hardness to new value. See Programming section. F. Remove meter housing, free us turbine and flush with clean water. DO NOT DISASSEMBLE TURBINE FROM METER HOUSING. Turbine should spin freely, if not, replace meter ! G. Repair leaky plumbing and/or fixtures !

Note: 1: Use of resin cleaners in an unvented enclosure is not recommended.

**Clorox is a registered trademark of The Clorox Company.*

Disinfection of Water Conditioners

The materials of construction of the modern water conditioner will not support bacterial growth, nor will these materials contaminate a water supply. However, the normal conditions existing during shipping, storage and installation indicate the advisability of disinfecting a conditioner after installation, before the conditioner is used to treat potable water. In addition, during normal use, a conditioner may become fouled with organic matter or in some cases with bacteria from the water supply.

Thus every conditioner should be disinfected after installation, some will require periodic disinfection during their normal life, and in a few cases disinfection with every regeneration would be recommended.

Depending upon the conditions of use, the style of conditioner, the type of ion exchanger, and the disinfectant available, a choice can be made among the following methods.

Sodium or Calcium Hypochlorite

Application

These materials are satisfactory for use with polystyrene resins, synthetic gel zeolite, greensand and bentonites.

5.25% Sodium Hypochlorite

These solutions are available under trade names such as Clorox Bleach*. If stronger solutions are used, such as those sold for commercial laundries, adjust the dosage accordingly.

1. Dosage
 - A. Polystyrene resin: 1.2 fluid ounces per cubic foot.
 - B. Non-resinous exchangers: 0.8 fluid ounce per cubic foot.

2. Brine tank conditioners
 - A. Backwash the conditioner and add the required amount of hypochlorite solution to the brine well of the brine tank. (The brine tank should have water in it to permit the solution to be carried into the conditioner.)
 - B. Proceed with the normal regeneration.

Calcium Hypochlorite

Calcium hypochlorite, 70% available chlorine, is available in several forms including tablets and granules. These solid materials may be used directly without dissolving before use.

1. Dosage
 - A. Two grains (approximately 0.1 ounce) per cubic foot.
2. Brine tank conditioners
 - A. Backwash the conditioner and add the required amount of hypochlorite to the brine well of the brine tank. (The brine tank should have water in it to permit the chlorine solution to be carried into the conditioner.)
 - B. Proceed with the normal regeneration.



